

**Septic System  
Maintenance  
Galien River Watershed  
Implementation Project  
August 3, 2011**

Ken Priest

Supervising Sanitarian

Berrien County Health Department



# How a Septic System Works

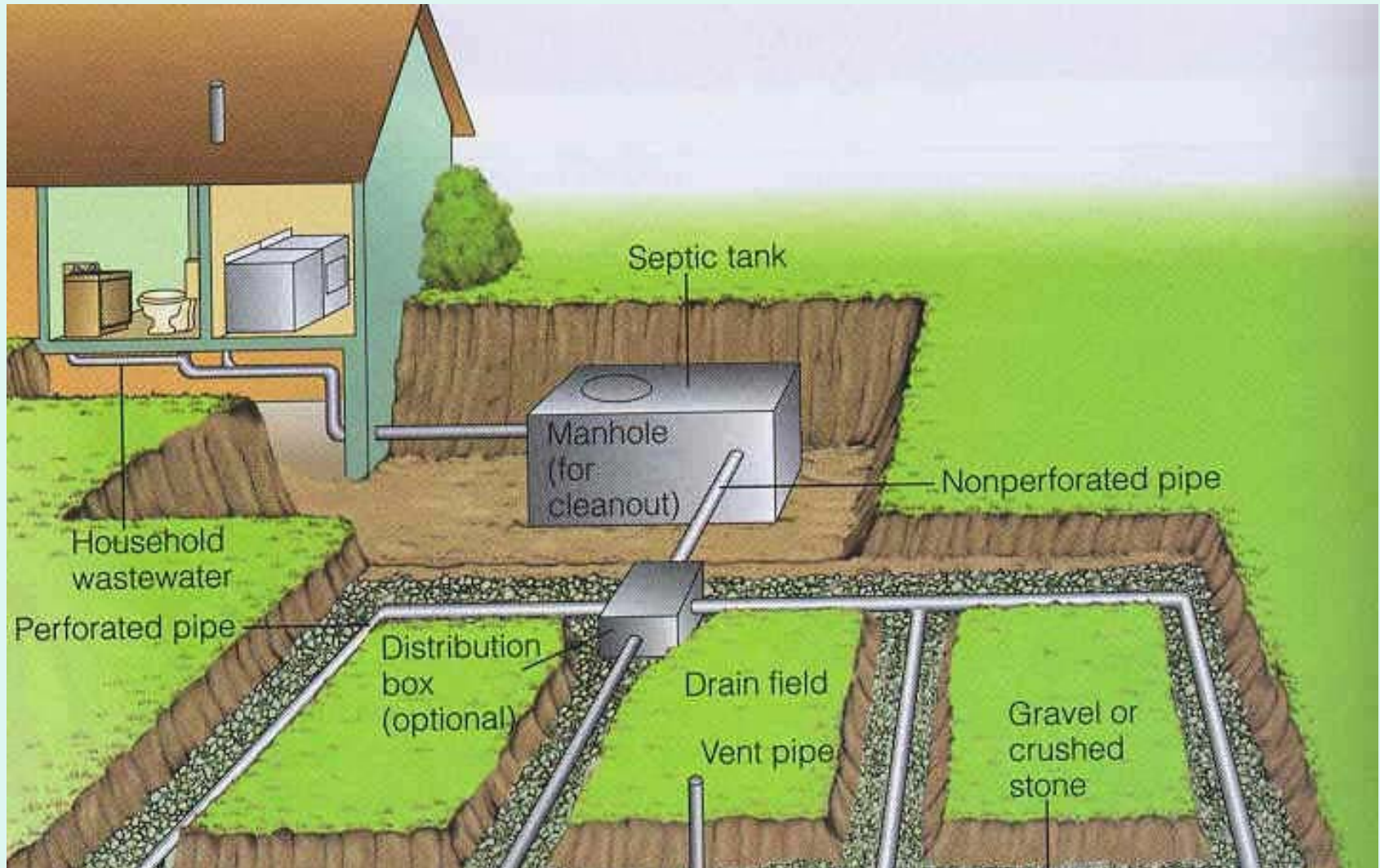

# Typical Septic Tank

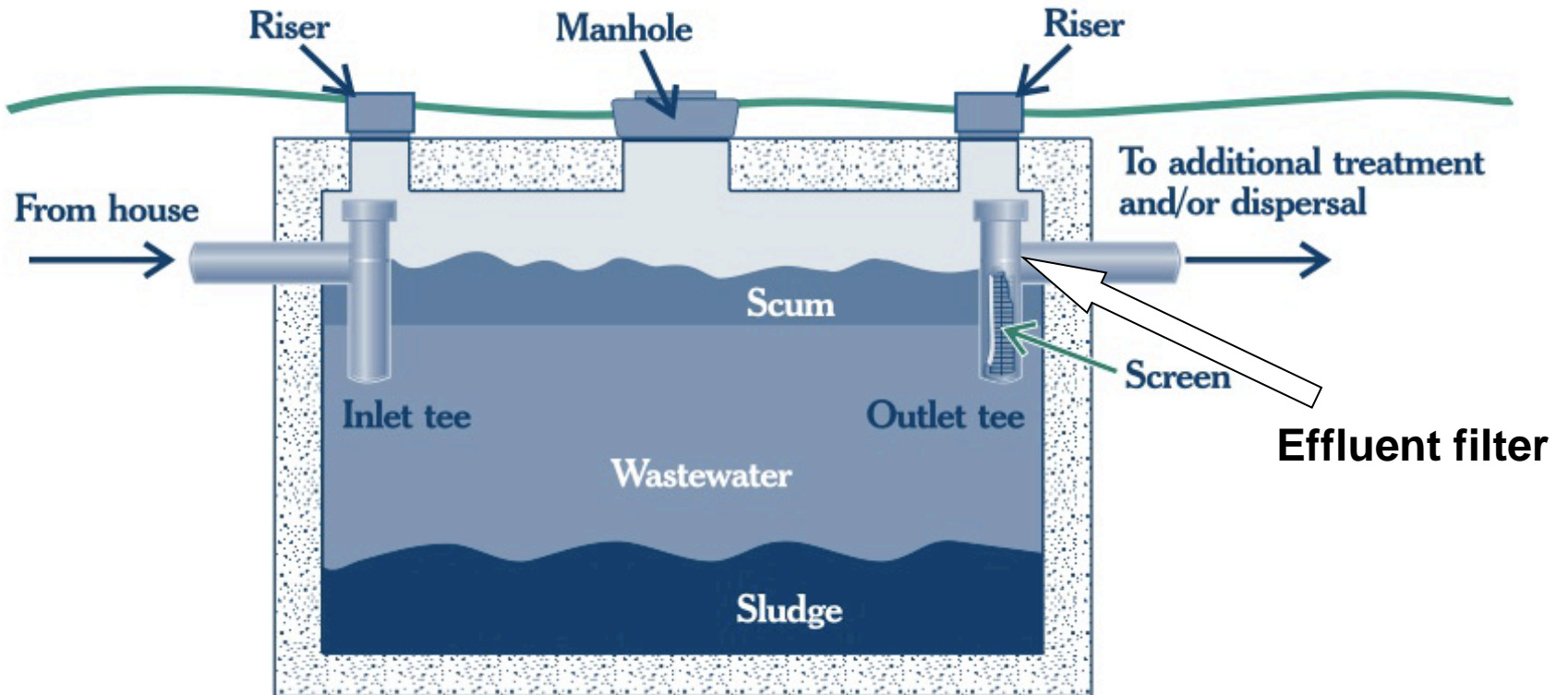

# Types of Effluent Filters

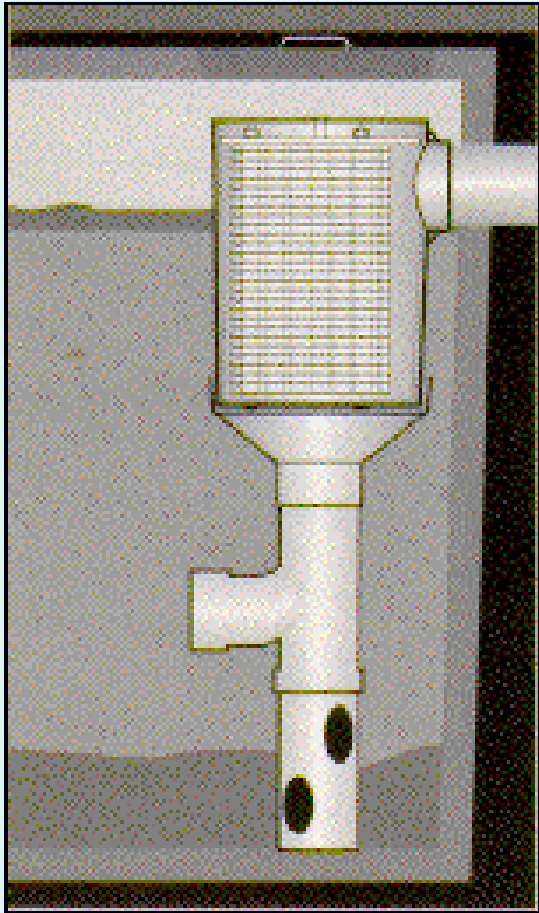

# Alternating Valves

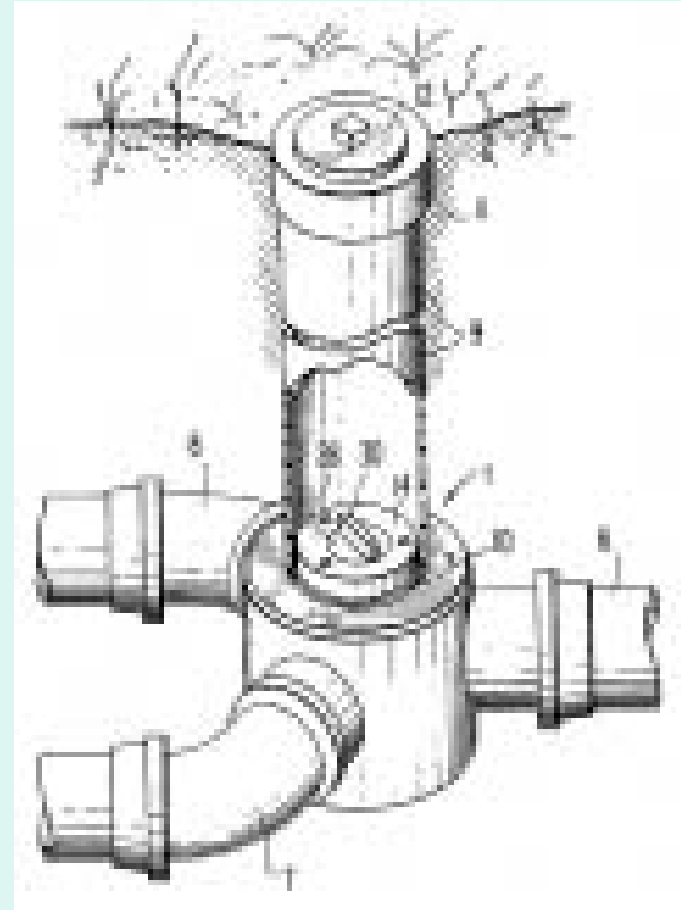

# Drain Bed and Drain Field



# Mound System

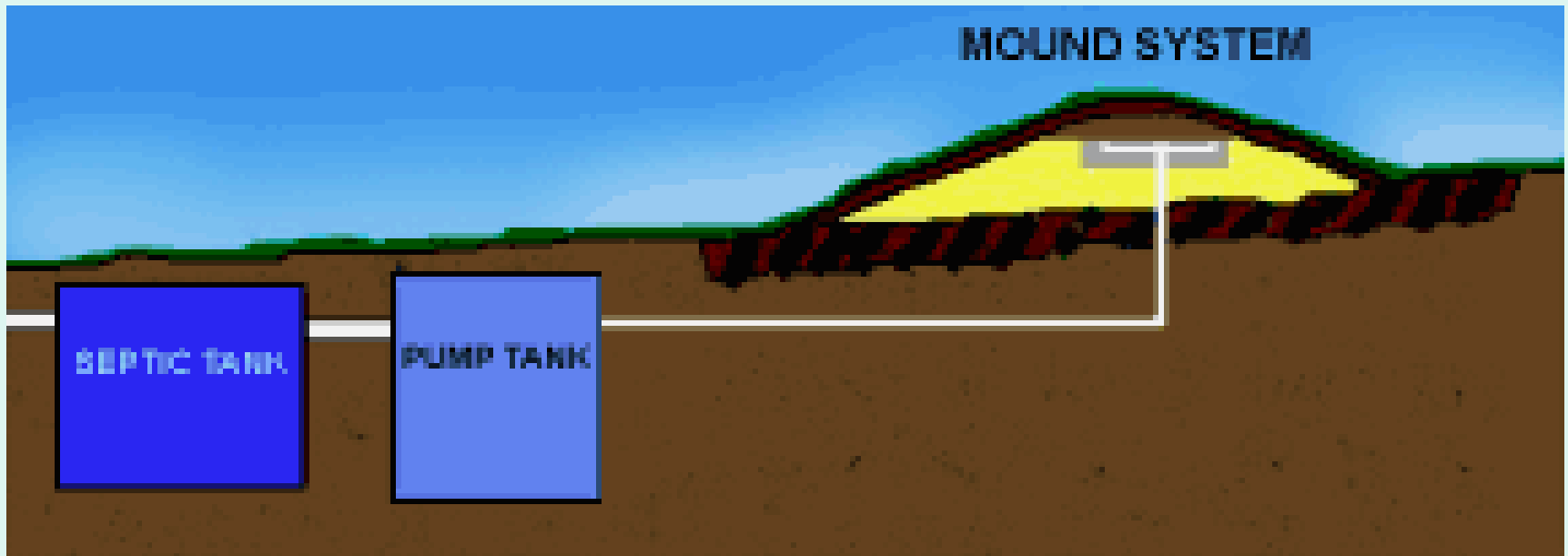

# Mound System

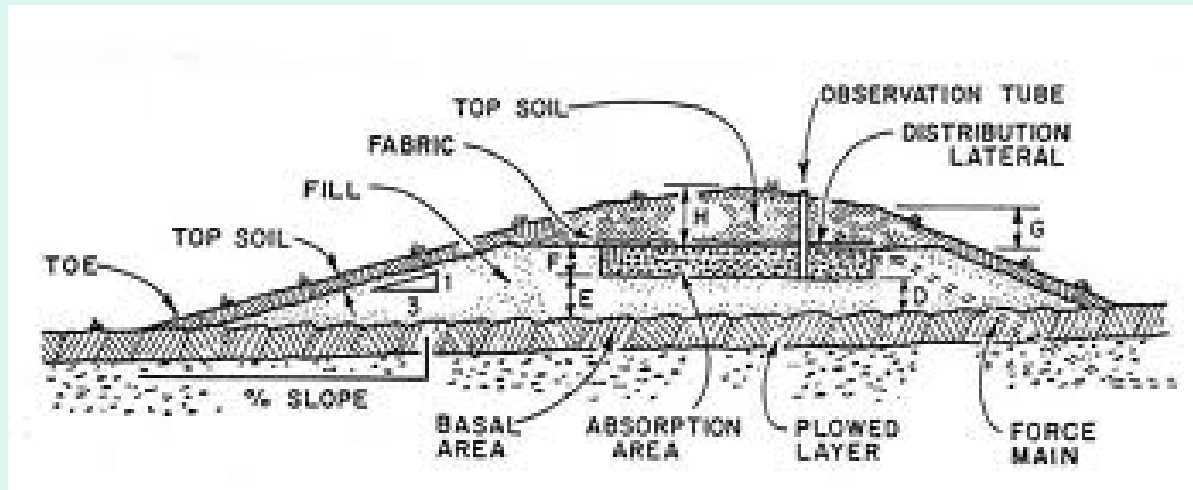



# Soil Profiles

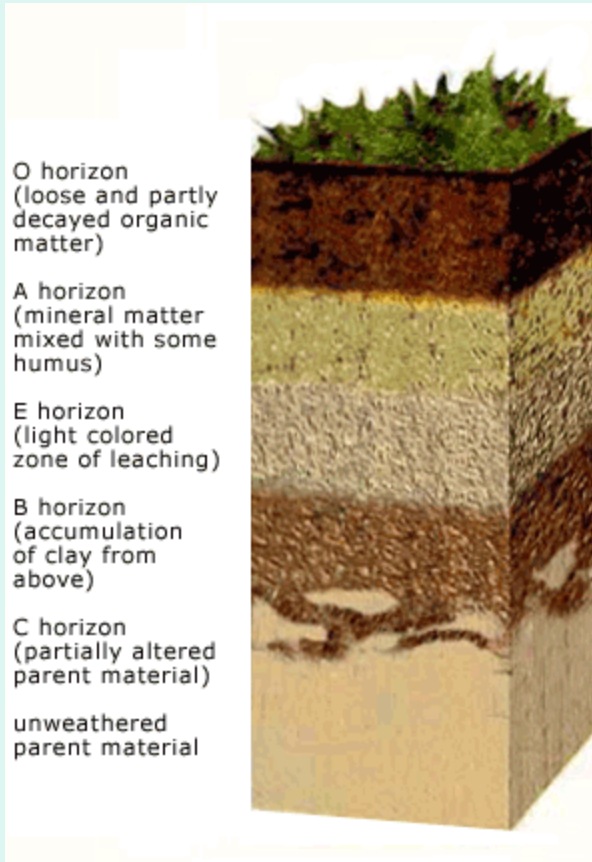

# Isolation Distance

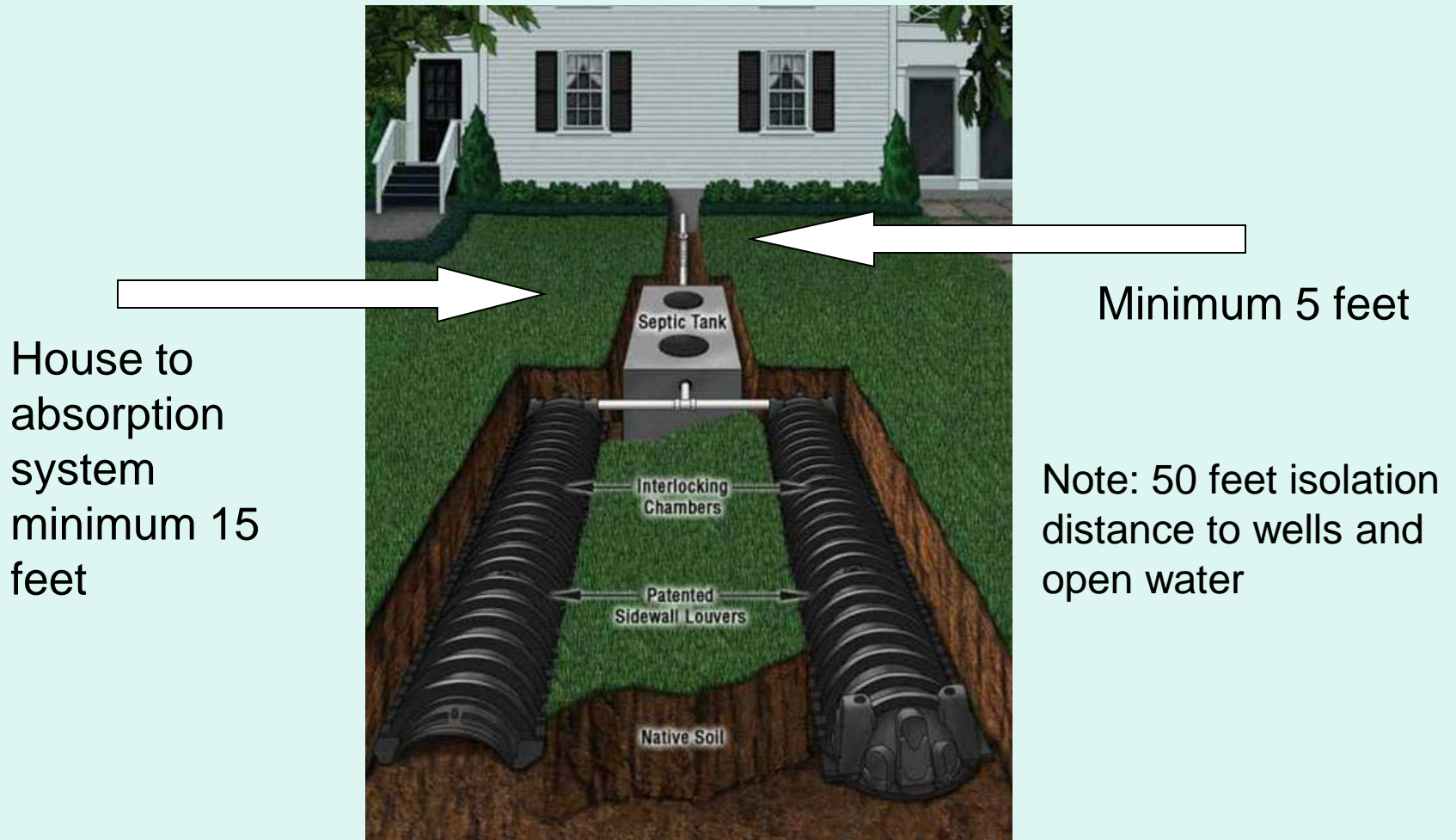

House to  
absorption  
system  
minimum 15  
feet

Minimum 5 feet

Note: 50 feet isolation  
distance to wells and  
open water

# Subdivisions and Site Condominiums



# Alternative Systems: Aerobic Treatment

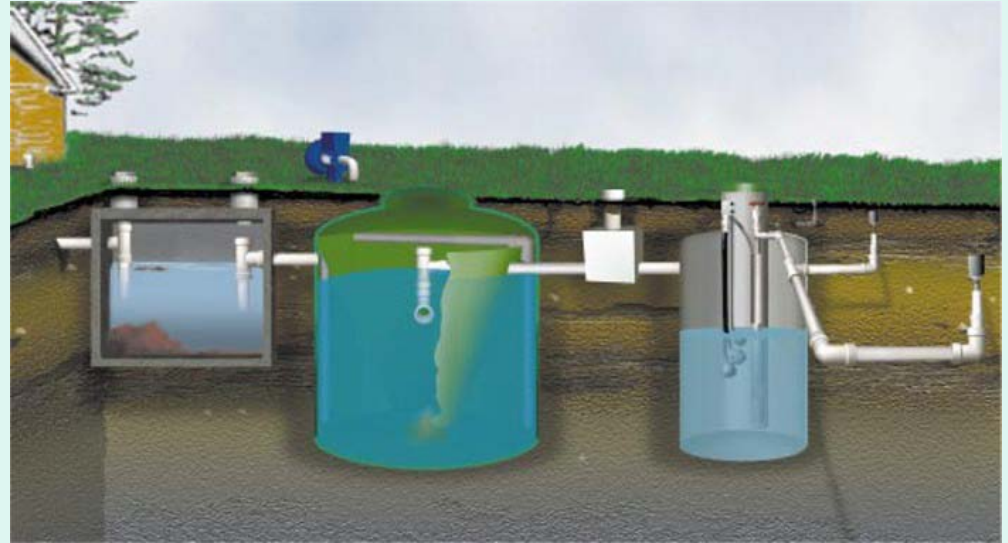
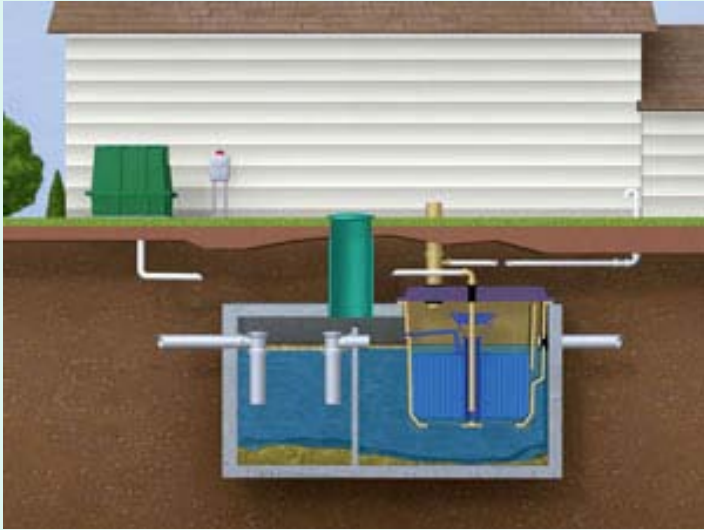

Nitrogen Reduction System

# Maintenance: Pumping



# Maintenance: Pumping

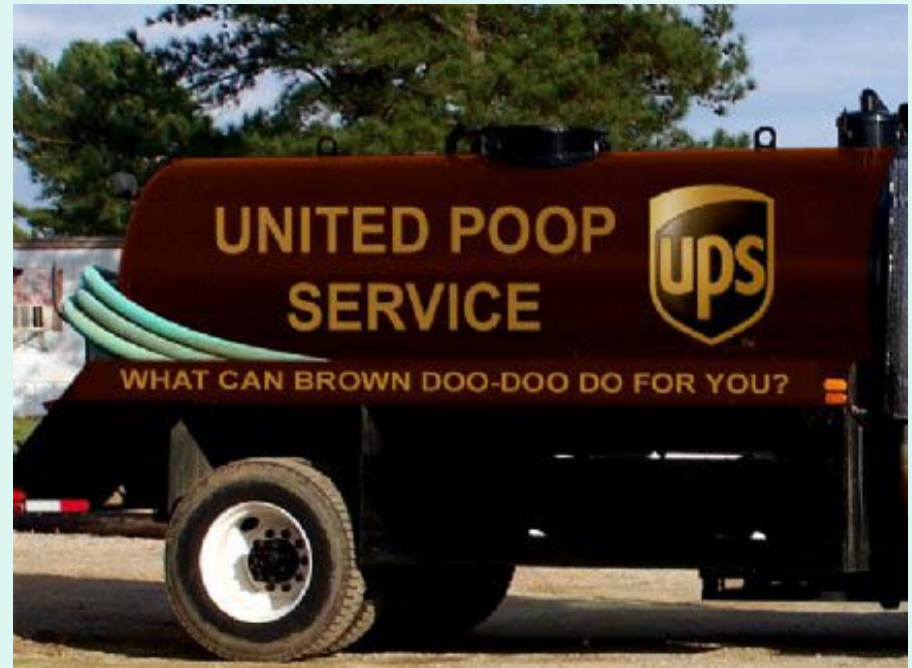
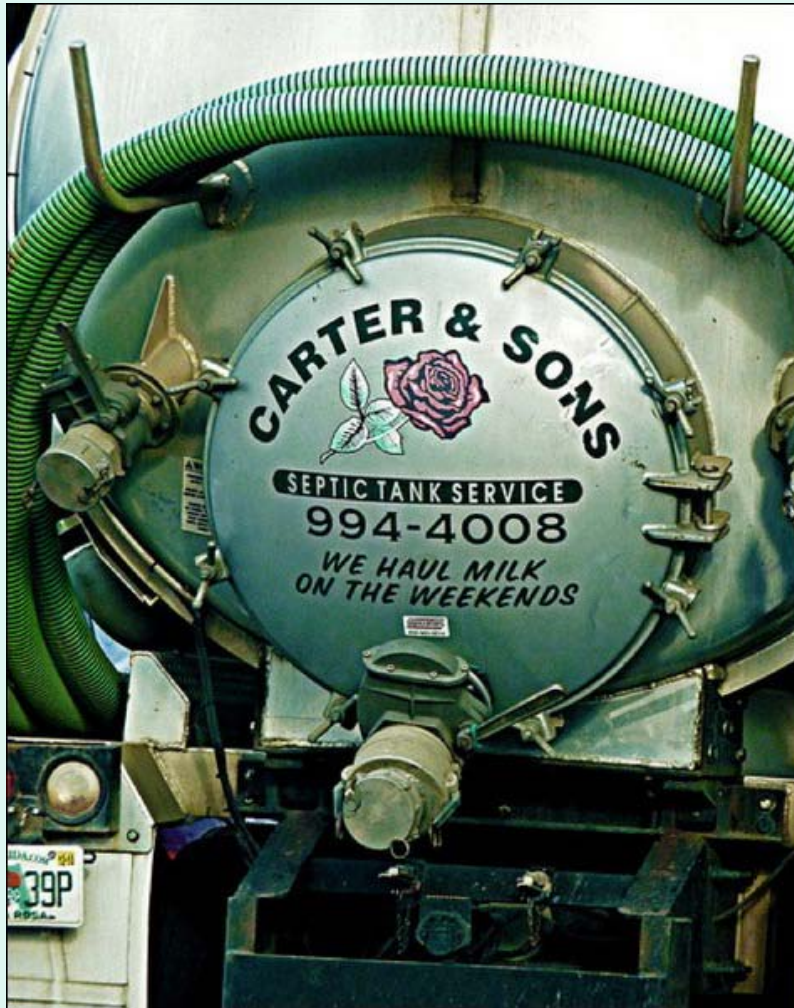

# Maintenance

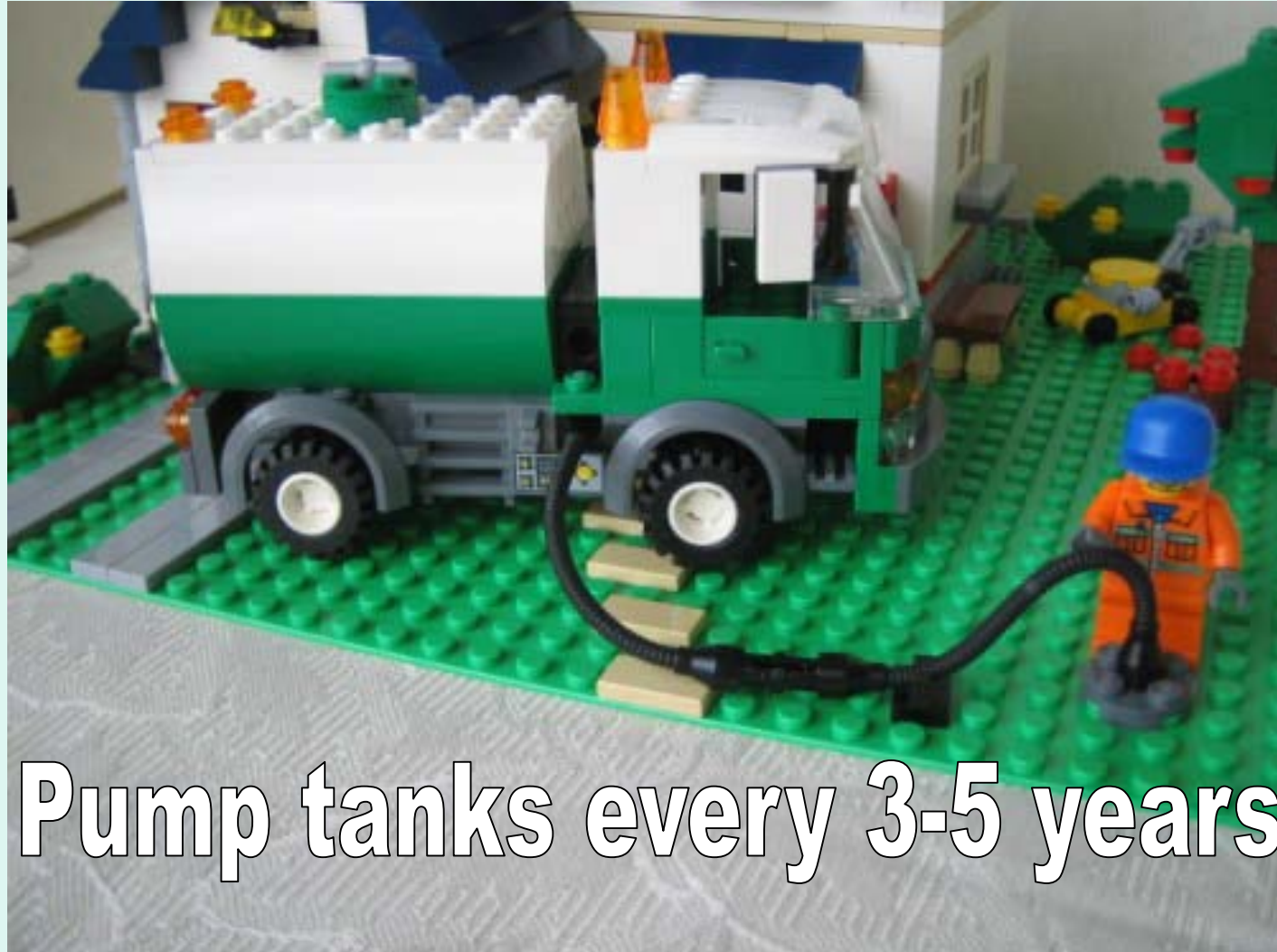

Pump tanks every 3-5 years

# Clean filters





# Additives



# Questions?

**Call**

**(269) 927-5623**

**for questions**

